

固化燈使用說明

MEGA CURE

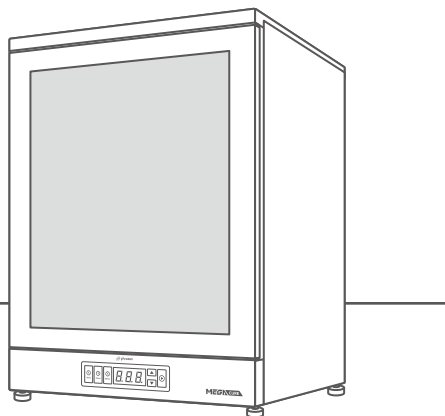

01 啟動電源

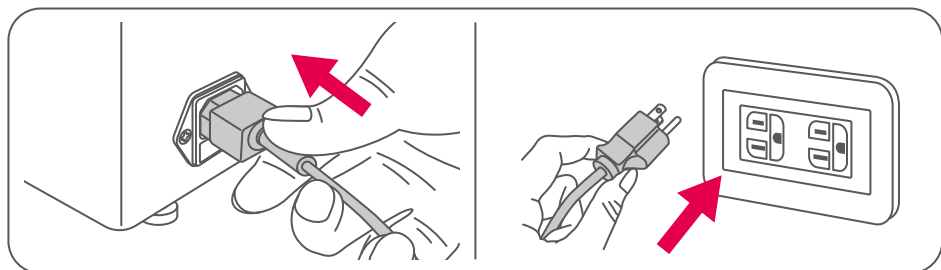

機台插上電源線

將電源線插上機台。

連接電源

將電源線插上插座，機台立即啟動。若要關閉電源請移除插頭。

02 設定固化時間

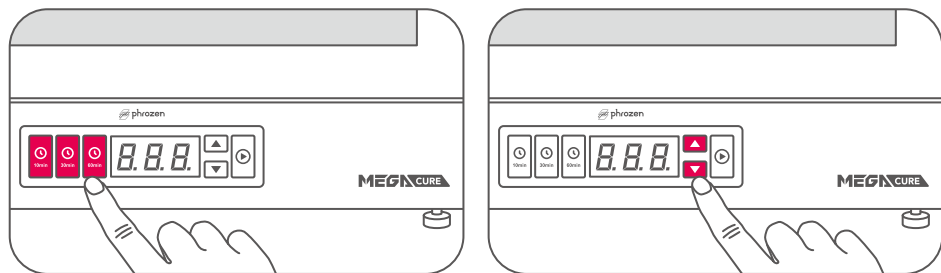

固化時間預設模式

此模式可快速選擇三種預設固化時間，分別為10分鐘、30分鐘及60分鐘。

手動調整固化時間

點擊上下鍵，每次可增減1分鐘。長按上下鍵，則可快速增減分鐘數。

03 固化燈運轉

關上機台遮光門，按下▶按鈕，固化燈即開始運轉。

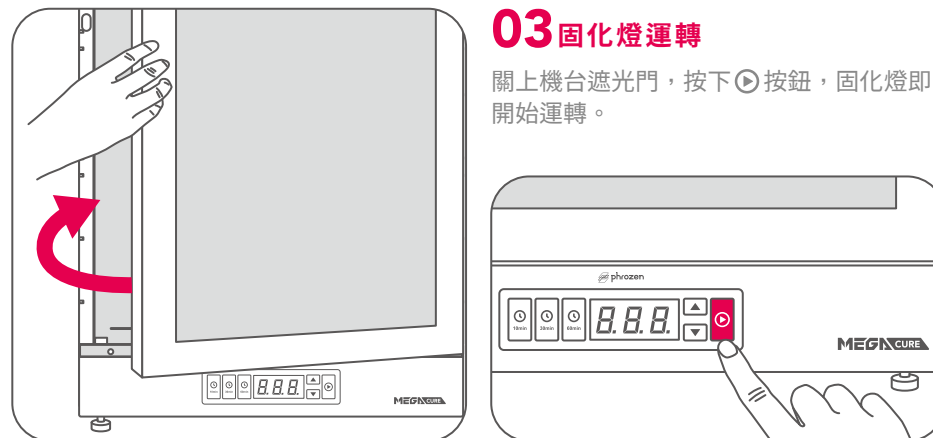

注意 ⚠ 事項

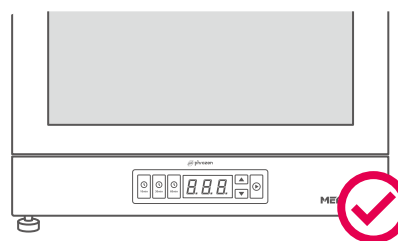

固化燈需確實關上遮光門，才能啟動固化燈。

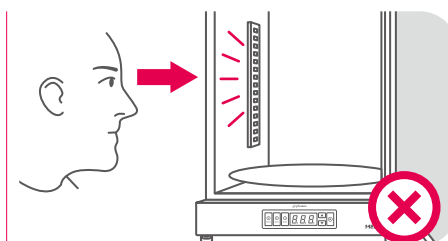

請勿在未關上遮光門的情況下直視固化燈光源，以免造成眼部損傷。

8歲以上兒童、肢體及行為障礙者需在法定監護人的指導下使用本產品，以確保使用者知悉所涉及的風險。禁止兒童在沒有監護人的陪同下使用本產品。

未經法定監護人陪同，禁止兒童清潔或維護本產品。

保養方式 如需外觀清潔請用酒精擦拭，請勿用油性或腐蝕性的液體擦拭。



Facebook



Facebook
台灣站社團



YouTube



Instagram



UV Curing Lamp User Guide

MEGN CURE

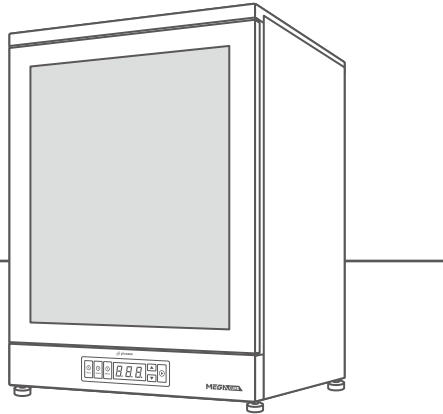

01 Power Supply & Light Switch

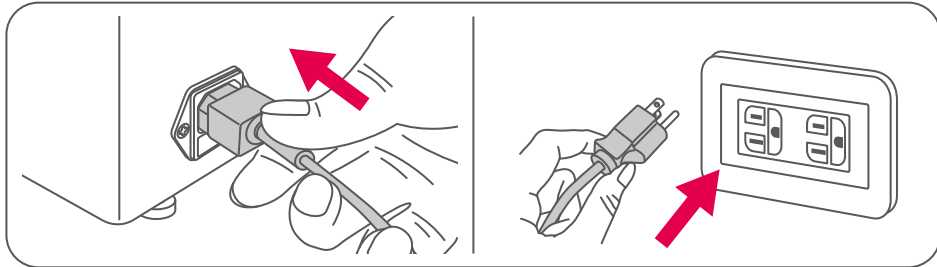

Plug in the power cable

Connect the power cable to the device.

Connect cable to electrical outlet

Once the power cable has been plugged in, the device will turn on immediately. To turn off the device, please plug out the power cable.

02 Set Curing Time

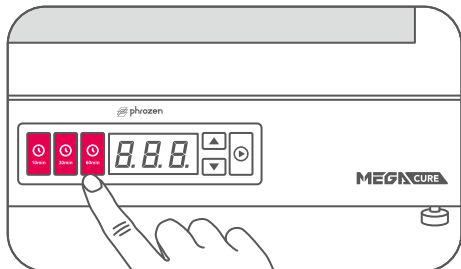

For Preset Curing Mode

This comes with three curing time settings: 10 min, 30 min, 60 min.

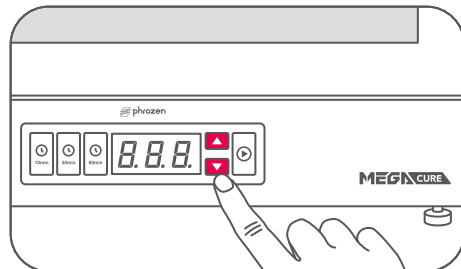

For Custom Curing Mode

Click on the up and down keys to increase or decrease time by 1 minute. Long press the keys to quickly increase or decrease the minutes.

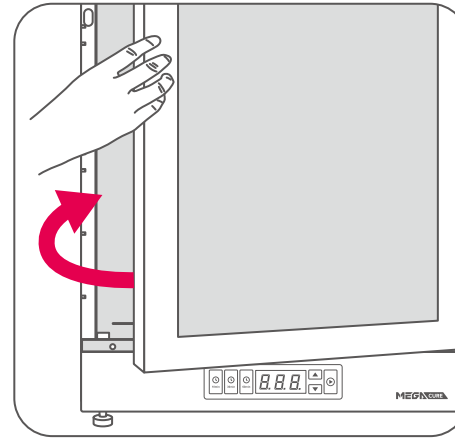

03 How to Operate the UV Curing Lamp

Close the UV lamp cover. Click on the Power button. The curing lamp will begin operation.

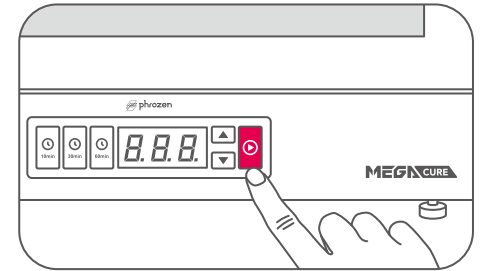

Warning

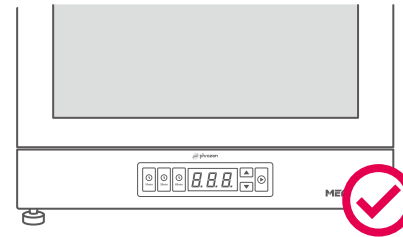

The UV lamp needs to be closed completely for the device to begin operation.

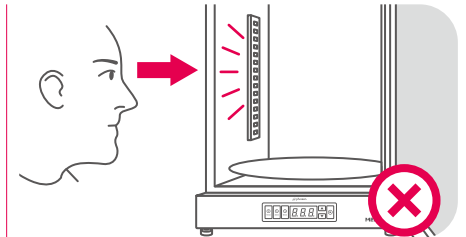

Do not stare at the UV curing lights without closing the UV lamp as this may cause damage to your eyes.

This appliance can be used by children aged 8 and above as well as by persons with reduced physical, sensory, or mental capabilities, if supervised or given instruction regarding the use of the appliance in a safe way, to ensure that the hazards involved are understood. Children are NOT allowed to play with the appliance.

Children are NOT allowed to clean or provide device maintenance without adult supervision.

Standard Maintenance Procedure

Please use sanitizing alcohol to clean the outside of your device. Do not use any oily or corrosive liquids to clean the device.



Facebook



Facebook Group



YouTube



Instagram